

Cautions:

Compare the gas spring that currently on the vehicle or cupboard and replacement gas spring.
If the gas spring does not match, then do not attempt to use the replacement gas spring.
There is a danger in using a gas spring that is not specifically made an application.

Mounting dimensions tables

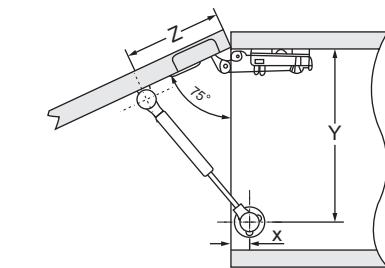
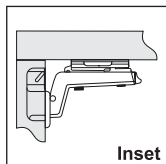
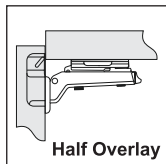
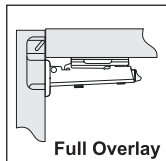

Mounting Dimensions	Dim.	Overlay		
		X	Y	Z
Full Overlay		25	260	100
Half Overlay		25	266	100
Inset		45	278	100

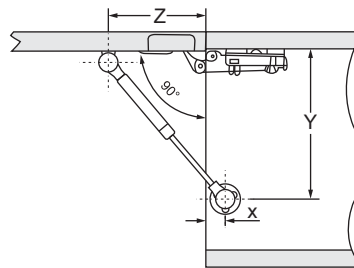

Mounting Dimensions	Dim.	Overlay		
		X	Y	Z
Full Overlay		25	238	100
Half Overlay		25	245	100
Inset		45	255	100

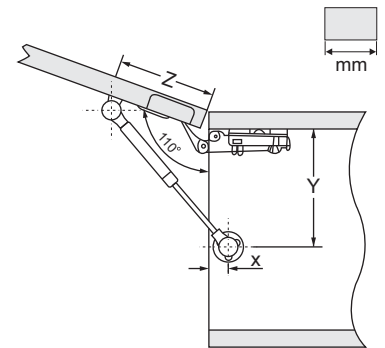

Mounting Dimensions	Dim.	Overlay		
		X	Y	Z
Full Overlay		25	215	90
Half Overlay		25	227	90
Inset		45	239	90

Note

It is recommended to use 2 gas spring for parallel and synchronized opening action of large lids.

Warnings

- You must have another person to assist you, so that the gate, hook, trunk and/or lid is held open as the gas springs is being replaced. If the application has two gas springs, one gas spring is not enough output force to hold open the application. therefore, to avoid injure and damage, a second person is required.
- Do not open it.
- Do not approach the high temperature.

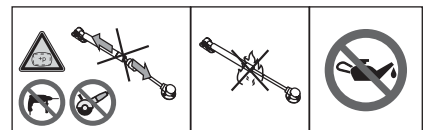

Installation Instructions

