

Specifications

• **Space required**

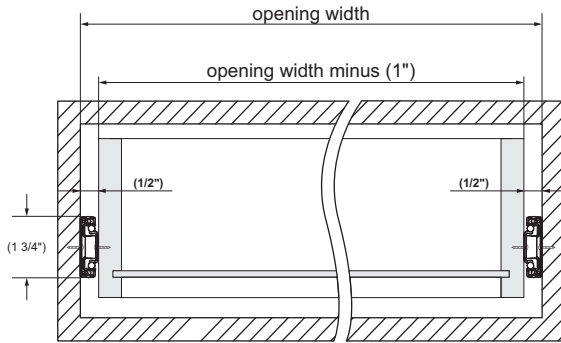

• **Extension length**

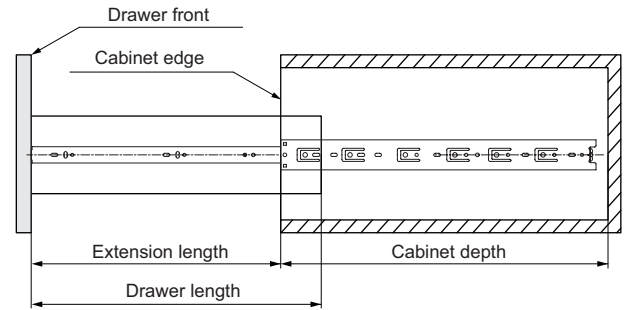

• **Holes pattern and length specifications**

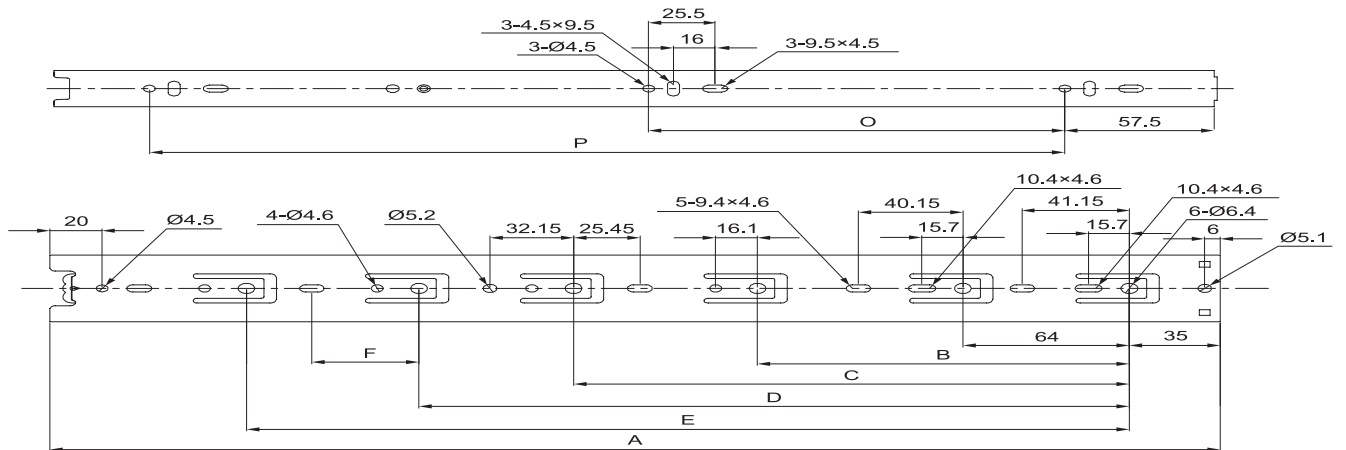

Item number	Drawer length	Extension length	Mounting holes distance							
			A	B	C	D	E	F	O	P
TCH-22102 700	(28") 700mm	703mm	700	224	352	--	544	50	288	576
TCH-22102 800	(32") 800mm	803mm	800	224	352	512	640	50	320	672
TCH-22102 900	(36") 900mm	903mm	900	224	352	608	736	50	352	736



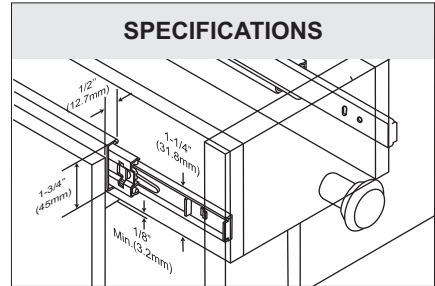
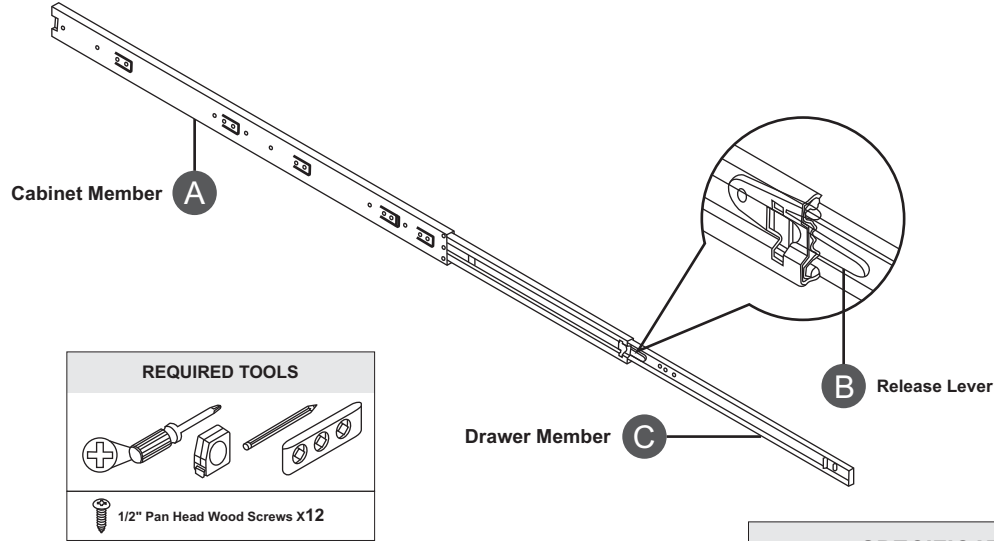

IMPORTANT:

- Please READ through all instructions before you begin.
- To avoid binding, drawer must be 1/2" narrower than cabinet opening on each side.
- Top and bottom of drawer should have 1/8" minimum clearance from cabinet opening.
- For face-frame cabinets, Rear Mount Socket is required.

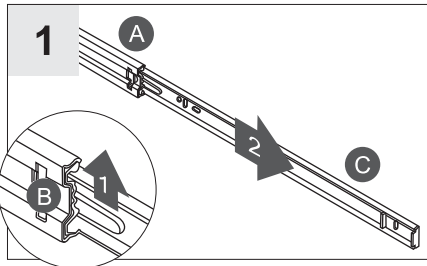

Press release lever (B). Remove drawer member (C) from the Cabinet member (A).

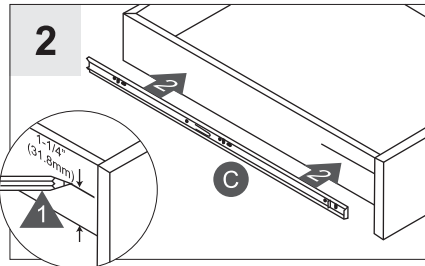

Mark 1-1/4" (32mm) from the bottom of the drawer side panel. Align the top of the drawer member (C) with mark.

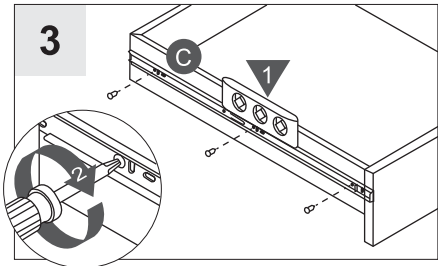

Make sure the drawer member (C) is level. Secure with screws. Repeat Steps 1-3 for the remaining drawer member.

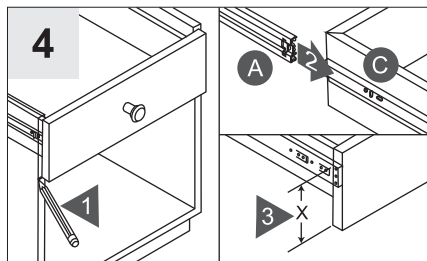

Determine drawer position. Mark bottom of the drawer front on the left and right sides. Place cabinet members (A) onto the drawer members (C). Measure "X".

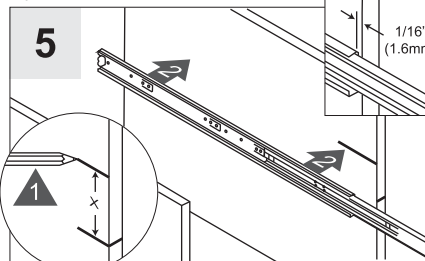

Mark "X" from the bottom of the mark. Repeat Step #1 to remove drawer member (C) from the Cabinet member (A). Align top of the cabinet member (A) with the mark, 1/16" from the front of the cabinet.

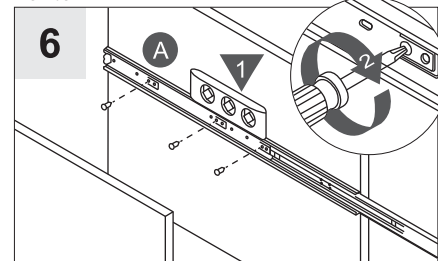

Make sure cabinet member (A) is level, secure with the screws. Repeat for the remaining cabinet member (A). Insert the drawer member (C) into the cabinet member (A) and close the drawer. Release member (B) will automatically lock.

